



COMETAL®

CICOMBEKISTING



INHOUDSOPGAVE

Voorblad	pag.1
Inhoudsopgave	pag.2
Cicom wandpanelen	pag.3
Afbindgaten Cicompanelen	pag.4
Cicom toebehoren	pag.5
Cicom algemeen	pag.9



Technische fiche

Cicombekisting

Omschrijving / principetekening / foto	Artikelnummer	Gewicht
CICOM 3000x2400mm galva CICOM 2650x2400mm galva CICOM 1000x2400mm galva CICOM 750x2400mm galva	CIG300240 CIG265240 CIG240100 CIG240075	407,84 kg 360,26 kg 140,00 kg 88,00 kg
CICOM 3000x2400mm gelakt CICOM 2650x2400mm gelakt	CIL300240 CIL265240	407,84 kg 360,26 kg
		





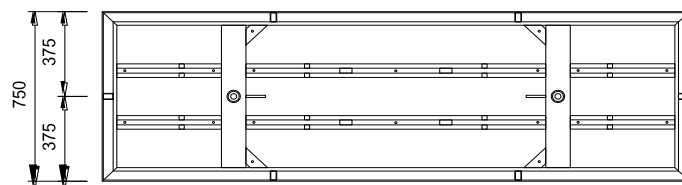
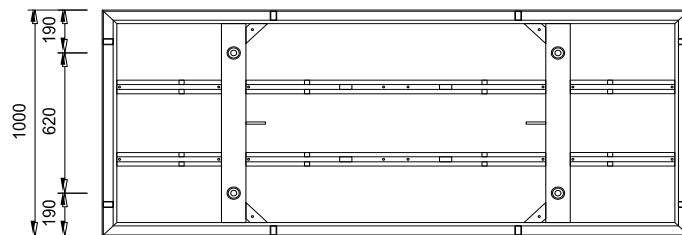
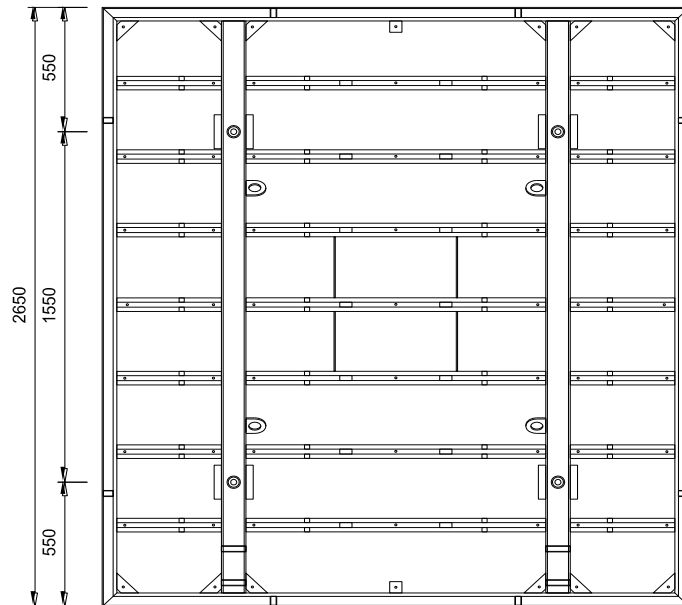
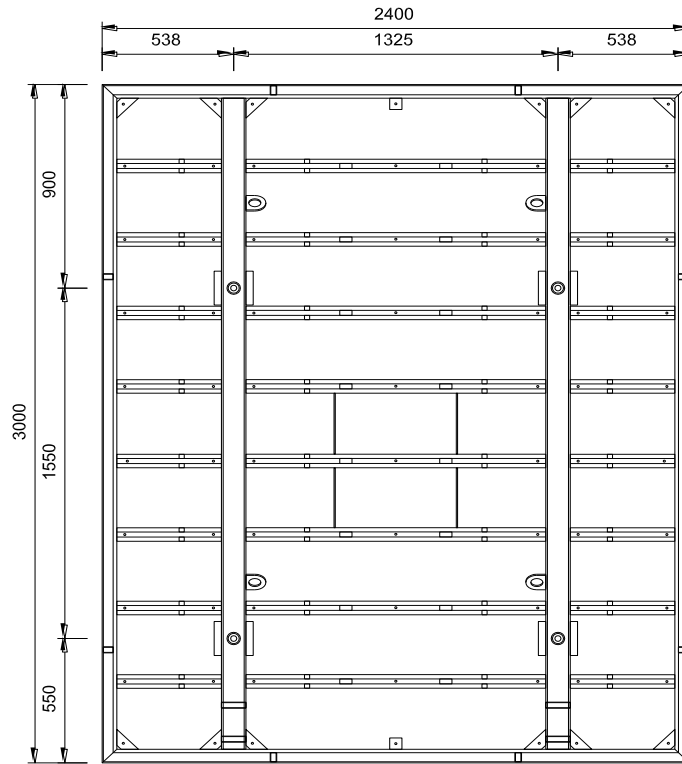

Technische fiche

Afbindgaten Cicompanelen



Technische fiche





Cicombekisting

Artikelnummer	Omschrijving / principetekening / foto	Gewicht
KLE003	VARIABELE SPANKLEM KORT 	3,37 kg
KLE004	VARIABELE SPANKLEM 	4,61 kg
KLE016 KLE021	DRAADKLEM BIMET-CICOM CPL. UNIVERSELE DRAADKLEM 	1,240 kg 1,290 kg
TKSZGT	KOPPELSET ZIJGATEN BIMET-CICOM CPL. 	1,300 kg



Technische fiche



Cicombekisting

Artikelnummer	Omschrijving / principetekening / foto	Gewicht
SPA015100 SPA015075	SPANSTAAF 15MM 1,00M 90kN SPANSTAAF 15MM 0,75M 90kN (spanstaven te gebruiken bij storthoogte tot 3000mm) 	1,50 kg 1,13 kg
SPA020100 SPA020075	SPANSTAAF 20MM 1,00M 140kN SPANSTAAF 20MM 0,75M 140kN (spanstaven te gebruiken bij storthoogte vanaf 3000mm) 	2,60 kg 1,95 kg
MOE015004	VLEUGELMOER + OPLEGPLAAT 15MM 	1,42 kg
MOE020002	VLEUGELMOER + OPLEGPLAAT 20MM 	1,10 kg



Technische fiche

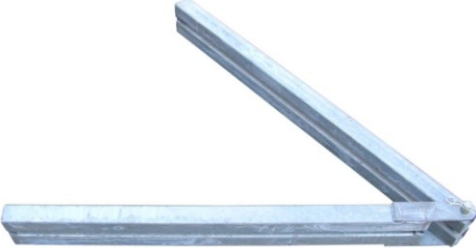

Cicombekisting

Artikelnummer	Omschrijving / principetekening / foto	Gewicht
PBA008165 PBA008100 PBA008075	PASBALK 1,65M UPN80 BIMET-CICOM PASBALK 1,00M UPN80 BIMET-CICOM PASBALK 0,75M UPN80 BIMET-CICOM 	29,50 kg 17,90 kg 13,50 kg
PSG025100 PSG025075 PSP025100 PSP025075 PCP001	SCHARNIERDEEL 1,00M GAT BIMET-CICOM SCHARNIERDEEL 0,75M GAT BIMET-CICOM SCHARNIERDEEL 1,00M PLAT BIMET-CICOM SCHARNIERDEEL 0,75M PLAT BIMET-CICOM PEN VAN DE SCHARNIERENDE PASBUIJS CPL. 	9,26 kg 7,07 kg 9,40 kg 7,21 kg 0,38 kg
VEI017 VEI020 VEI023 VEI024	LOOPSTEIGER BIMET-CICOM CPL. KOPLEUNING LS BIMET CPL. UNI-LOOPSTEIGER ALU 943MM VALLEUNING CPL 	16,40 kg 10,09 kg 6,80 kg 7,16 kg



Technische fiche

Cicombekisting

Artikelnummer	Omschrijving / principetekening / foto	Gewicht
RIC038002 RIC038007 RIC038008 RIB048400 RIB048600	ENKELE SCHOOR 38RL240 z KOP DUBBELE SCHOOR 38RL180-300 z KOPPEN DUBBELE SCHOOR 38RL180-360 z KOPPEN ENKELE SCHOOR 48RL400 z KOP ENKELE SCHOOR 48RL600 z KOP	14,85 kg 28,27 kg 30,17 kg 25,21 kg 39,31 kg
RIC052 RIC050 RIC051 RIC056 RIC055 RIC053 RIC057 RIC058 RIC059	RICHTSCHOOR MAMMOETH 4 z KOP RICHTSCHOOR MAMMOETH 6 z KOP RICHTSCHOOR MAMMOETH 8 z KOP RICHTSCHOOR BKS 4 z KOP RICHTSCHOOR BKS 5 z KOP RICHTSCHOOR BKS 6 z KOP RICHTSCHOOR BKS 7 z KOP RICHTSCHOOR BKS 8 z KOP RICHTSCHOOR BKS 9 z KOP	83,00 kg 103,00 kg 110,00 kg 165,86 kg 186,86 kg 207,86 kg 239,01 kg 260,01 kg 291,17 kg
RIC108	KLEMKOP BIMET-CICOM CPL. 	3,40 kg
HIJ011	KRAANHAAK ALCOM 1500KG CE 	9,40 kg



